



浙江基恒康门业有限公司

ZHEJIANG JIHENGKANG(JHK) DOOR INDUSTRY CO.,LTD

地址：中国浙江省金华市婺城新区临江工业园区星康路99号

Add : No.99 Xingkang Road, Linjiang Industry Park, Jinhua, Zhejiang Province, China

Mobile : +86-156-6953-8888

WhatsApp : +86-156-6953-8888

WeChat : JHKGROU(+86-156-6953-8888)

Zipcode : 321025

E-mail : zjzhk@zjzhk.com

Fax : 86-579-82220988

Web : www.zjzhk.com



Scan to visit

WHITER PRIMER DOOR

浙江基恒康门业有限公司

ZHEJIANG JIHENGKANG(JHK) DOOR INDUSTRY CO.,LTD



基恒康，全球优质木门供应商。

浙江基恒康门业有限公司成立于2000年，位于浙江省金华市，是国内生产模压门板的龙头企业，现已成为一家集研发、生产、销售、服务于一体大规模专业木门制造企业，致力于为全球消费者提供绿色环保的模压门板，模压门，板材和定制家具。基恒康现拥有员工200余人，标准化大型厂房生产面积共计60000平方米。

基恒康以“绝不放过任何一个小问题”为准则，执行健全标准的管理体系，贯彻落实可持续发展，严格控制质量问题，现已获得ISO9001:2015质量体系认证，ISO14001:2015环境管理体系认证，TSCA&CARB认证和FSC认证等国际权威证书。层层保障，只为让消费者放心买门，卖门，用门。

基恒康拥有自营出口权，在行业内率先打开模压门板国际市场，以高质量产品取得全球广大建筑商、批发商的青睐与信任，主打模压门板和模压门持续出口至美国，加拿大，法国，日本，韩国等50多个国家和地区，畅销于全球各大市场。

基恒康以管理变革为核心，以技术创新为驱动，持续推进产业升级，加大技术投资，不断引进国际一流自动化生产设备提高产量与质量。基恒康拥有专业的国际市场开发、产品设计团队，具备高度市场敏感度，注重产品研发，保持传统工艺，融入现代元素，引领产业变革，不断提高消费者生活品质，提供一次多选，一站购门的集中供应，致力于让每个家庭拥有更好的门。

基恒康始终以“优质绿色的原料，优质创新的设计，优质高效的生产，优质专业的服务”即“四优标准”为企业发展理念，一切以客户为出发点，提供具有市场竞争力的价格，为客户创造价值，同时基恒康具备根据客户要求提供量身定制产品的能力，配备专业销售人员，在售前售后不断给予客户解决方案和技术支持。

基恒康以专业为基础，诚信为宗旨，追求卓越，精益求精，20年匠心，专注打造优质木门。

Zhejiang JiHengKang(JHK) Door Industry Co., Ltd, established in 2000, is a large-scale manufacturer of Door Skins, Doors, Wood Boards and Wooden Furniture. JHK employs more than 150 workers, including Production department, QC department, Sales department and R&D department. With the efforts of our entire staff, the products of high quality are widely used in a variety of architecture. JHK has shared the broad masses of the worldwide market for over a decade.

Currently, JHK products are exported to more than 70 countries and regions through America, Europe, Southeast Asia and Middle-East. JHK has always focused on research, development and innovation. To accommodate seasonal demands of the market, JHK develops new products each quarter. In possession of 30,000 m² production area, JHK invested 4 semi-automatic production lines.

As the result of implementing a comprehensive internal management system, JHK has attained the latest ISO9001:2015 quality management system certification as well as the ISO14001:2015 environmental management system certification. To meet the ever-increasing customer demands, JHK uses high standard raw material with the certificates of TSCA&CARB and FSC. JHK strives to provide the top-quality products with reasonable prices, efficient production time and the most professional service. JHK always focuses on customers' needs and therefore provides tailored products and approaches clients actively to solve any problems they have.

With the variety of top-quality products JHK offers, we are confident that we will become your ideal partner. Your satisfaction is our priority.

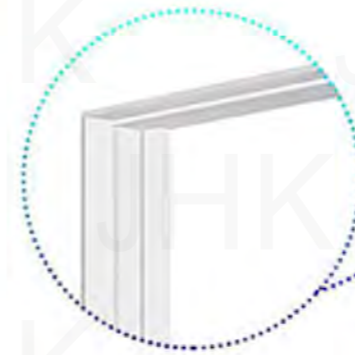

Solid Frame



Lock

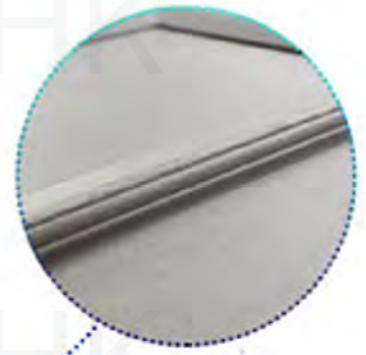

Door Skin
MDF Material
Density 860kg/m³



Whiter Primer
Water Paint
Green and Environmental

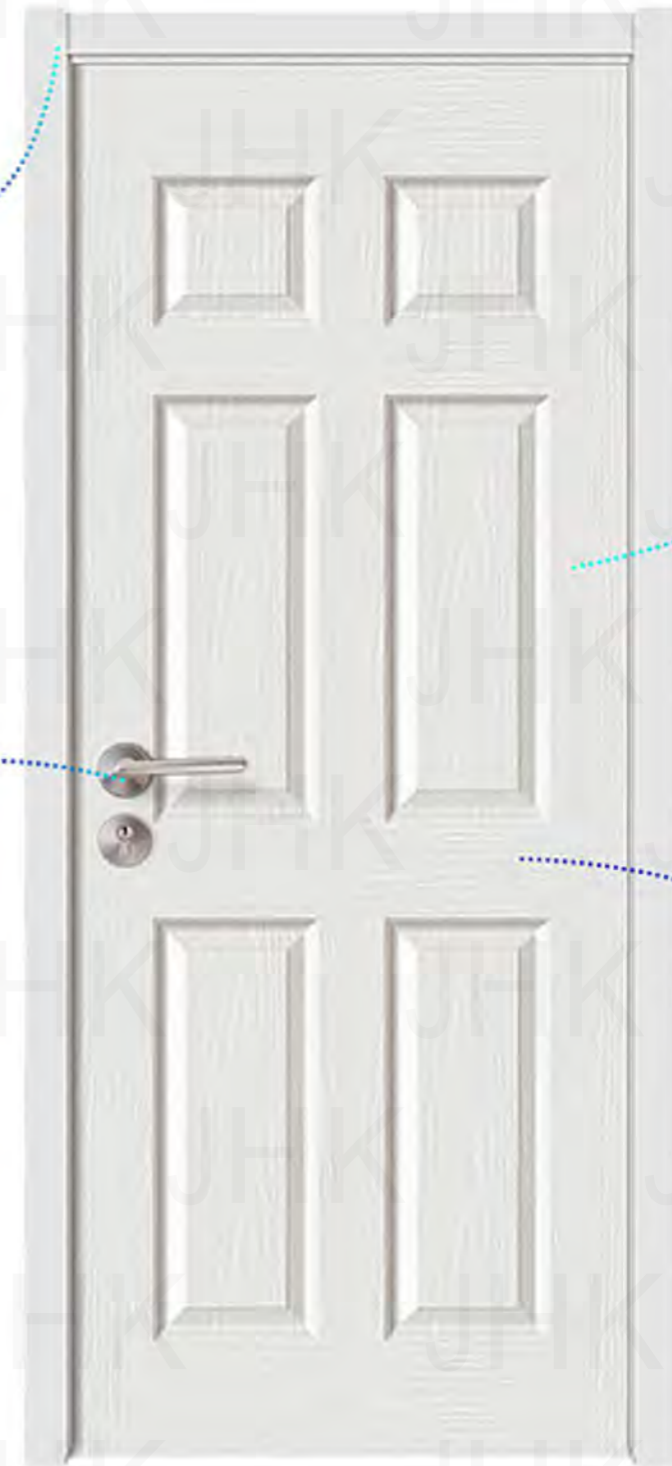

Type One : Flush Door Design JHK-F

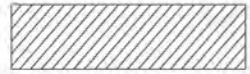

JHK-F01

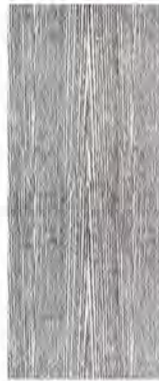

JHK-F02

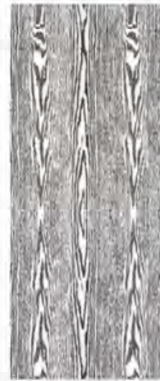

JHK-F03



JHK-F04

Type Two : Raised Door Design JHK-M

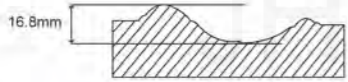

JHK-M01

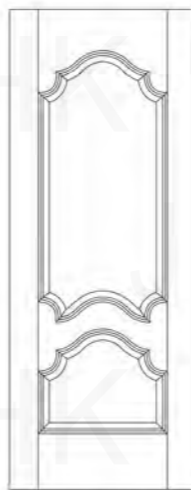

JHK-M02

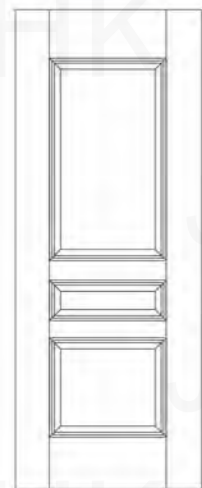

JHK-M03

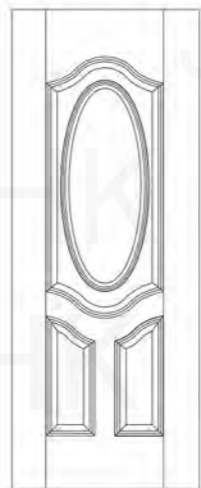

JHK-M04

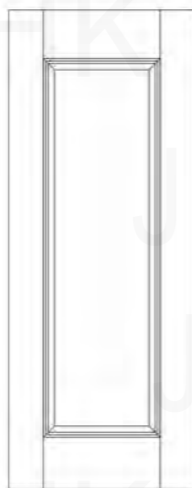

JHK-M10



JHK-M11

Type Three : 9mm Depth Door Design JHK-MS

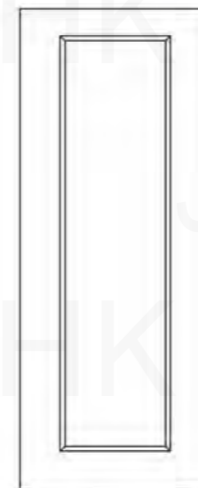
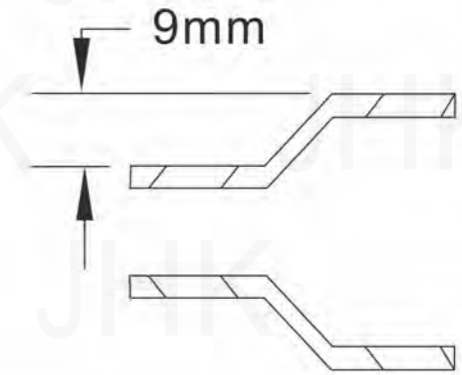

JHK-MS01-B

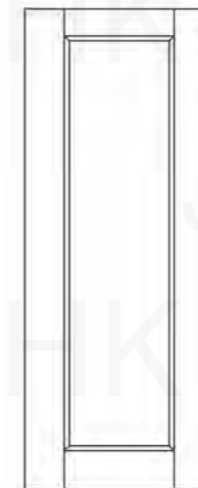

JHK-MS01-D

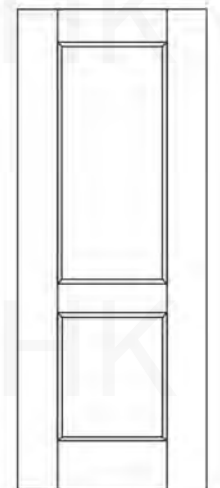

JHK-MS02

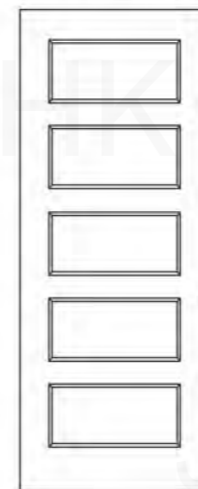

JHK-MS05

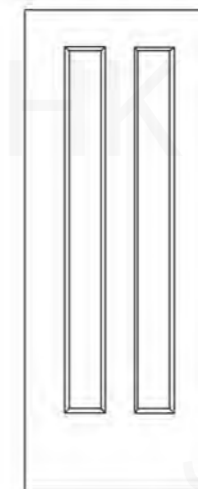

JHK-MS02-B

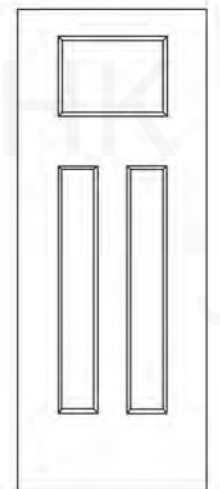

JHK-MS03-B

Type Four : 12mm Depth Door Design JHK-S

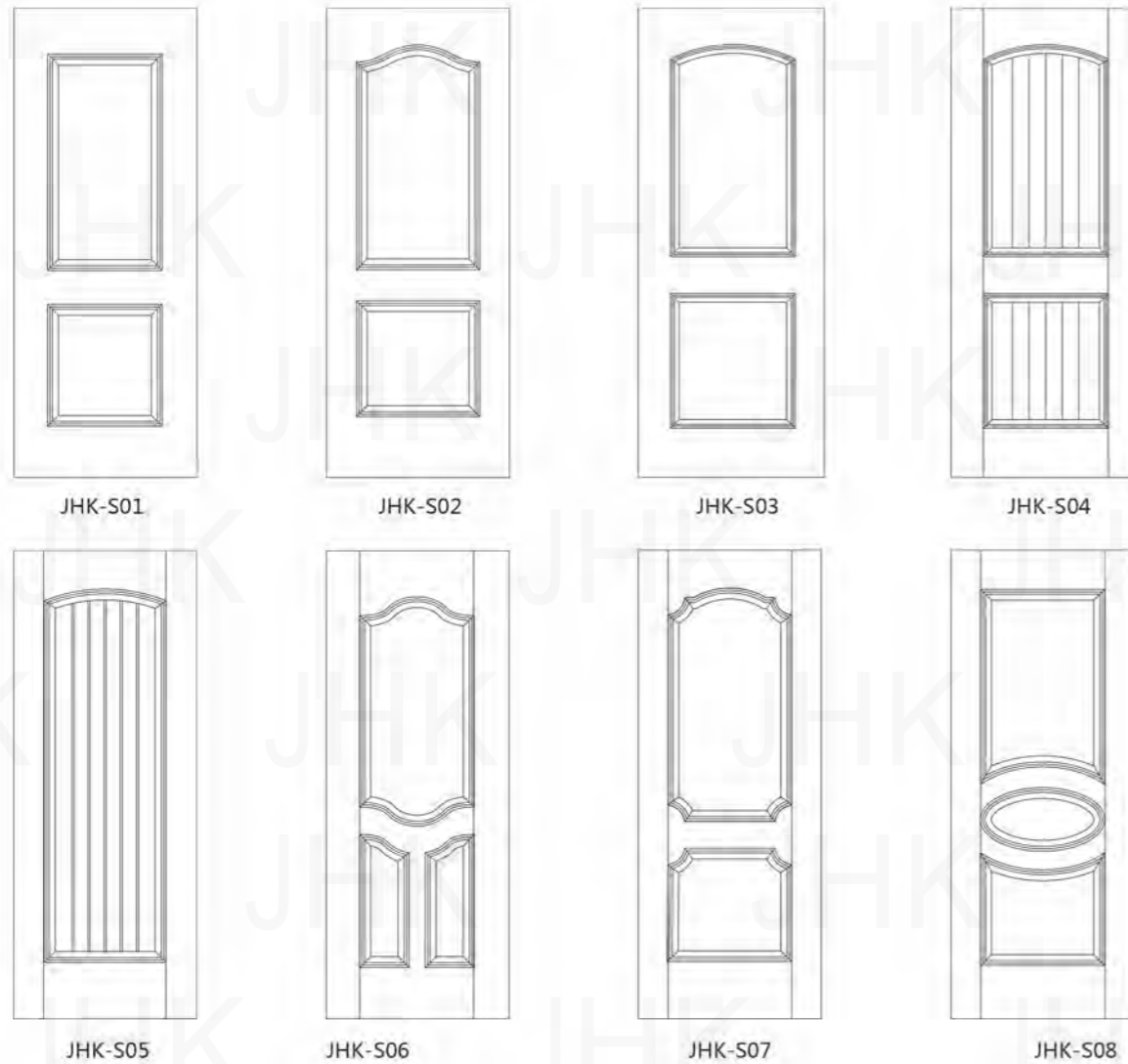
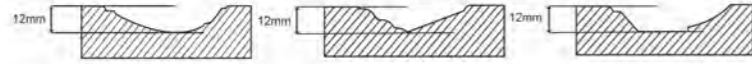

Type five: 8mm Depth Door Design JHK-0

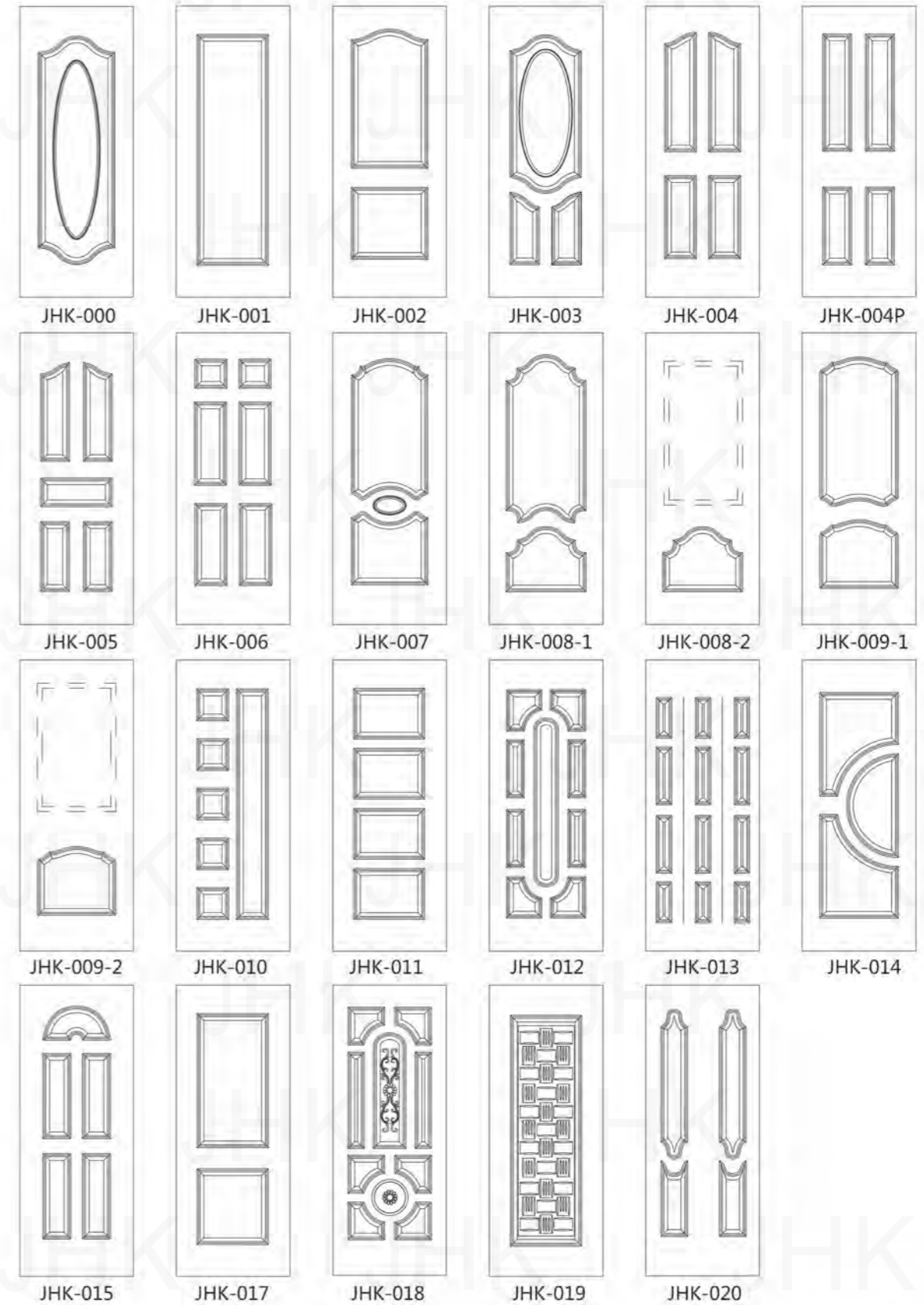

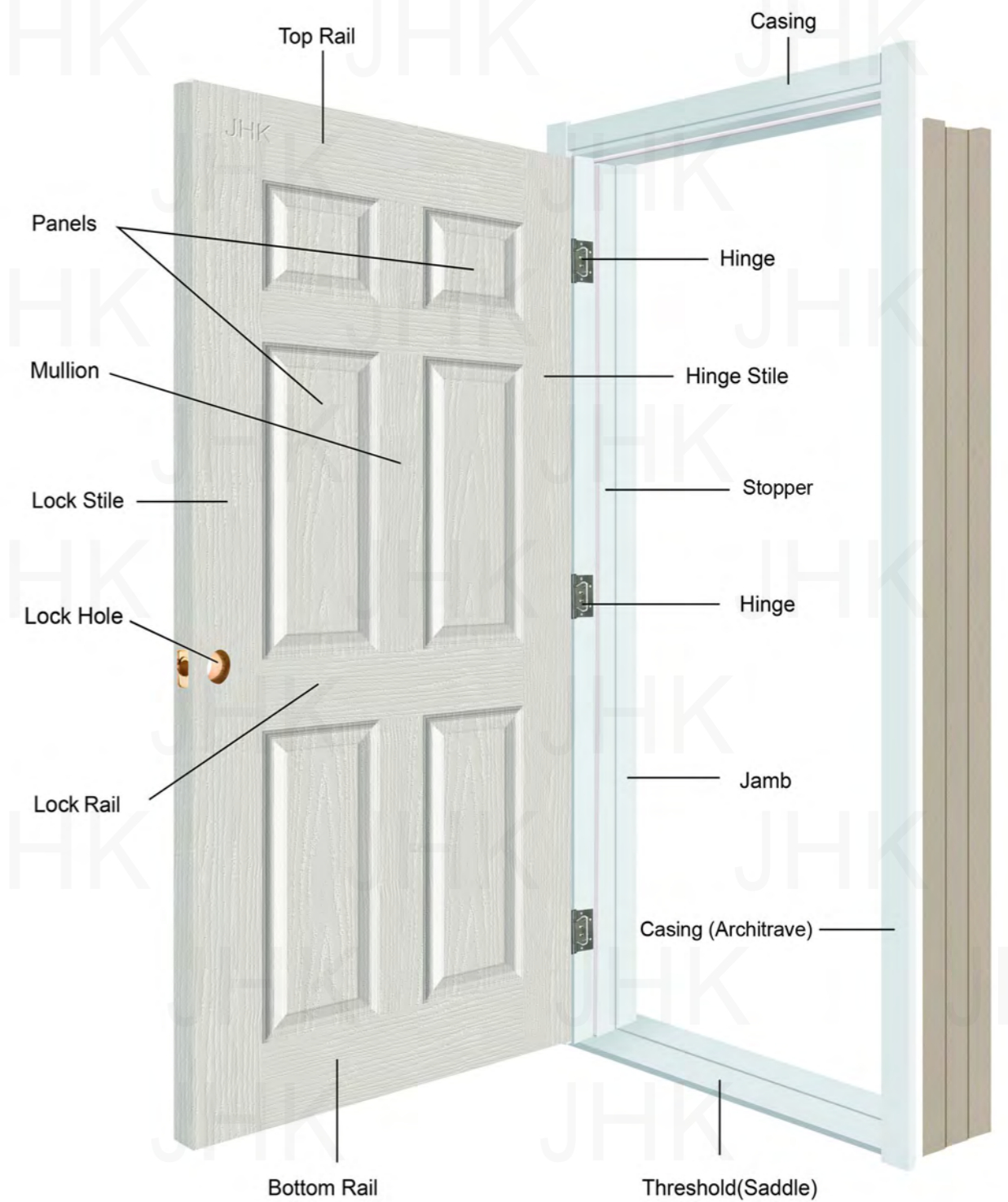

Whiter Primer Door

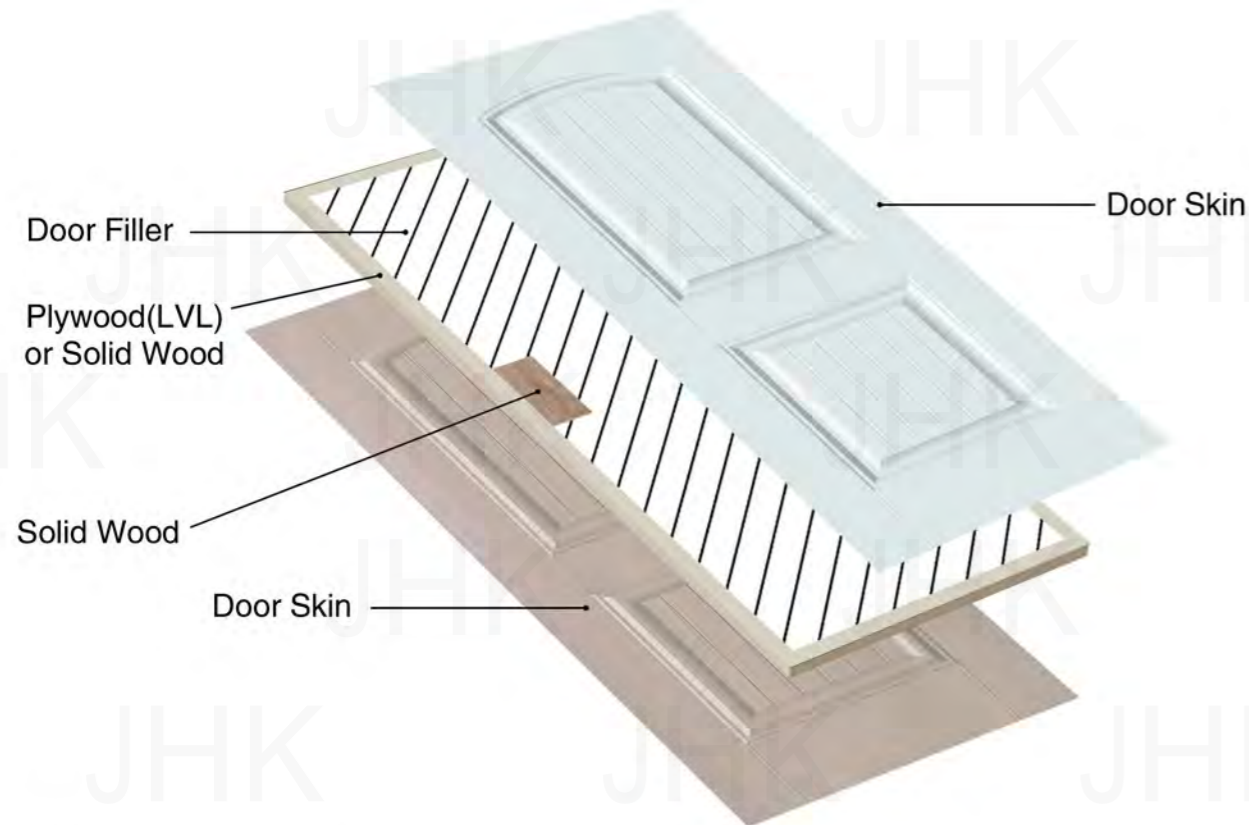
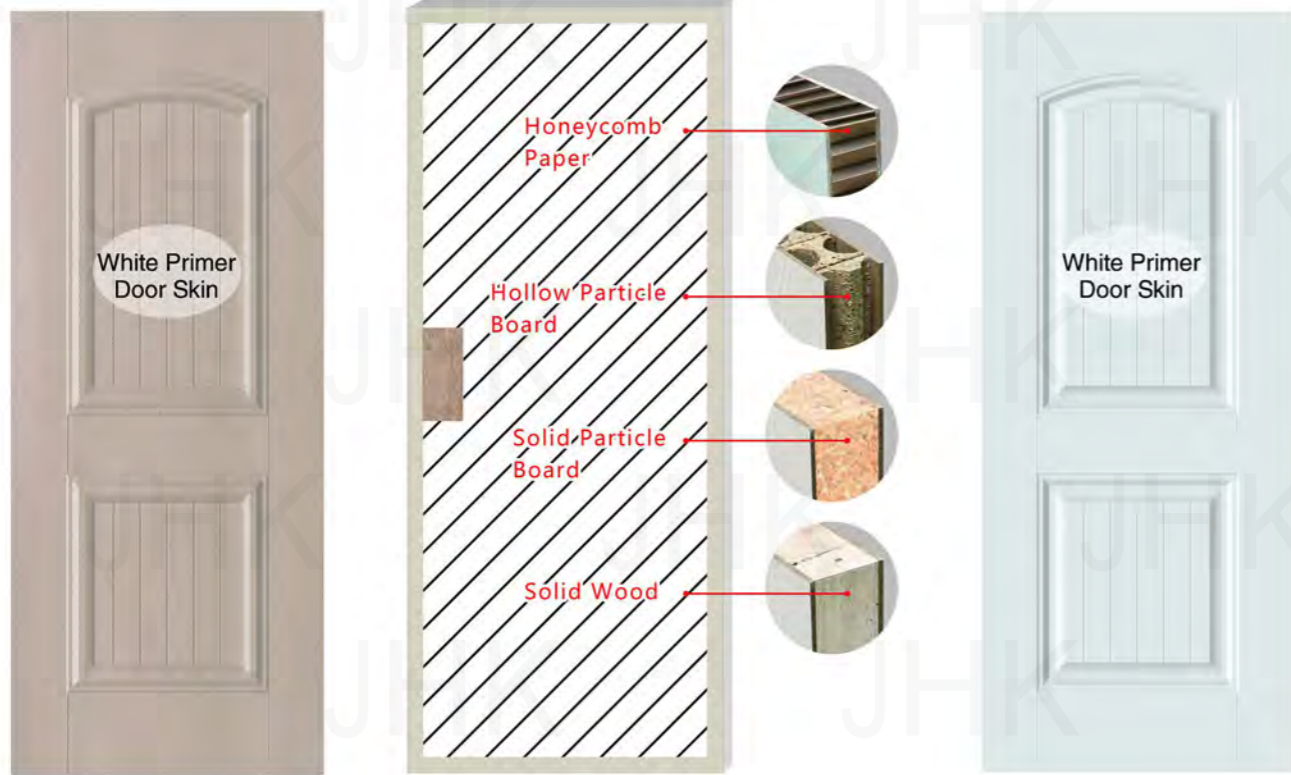

Whiter Primer Door

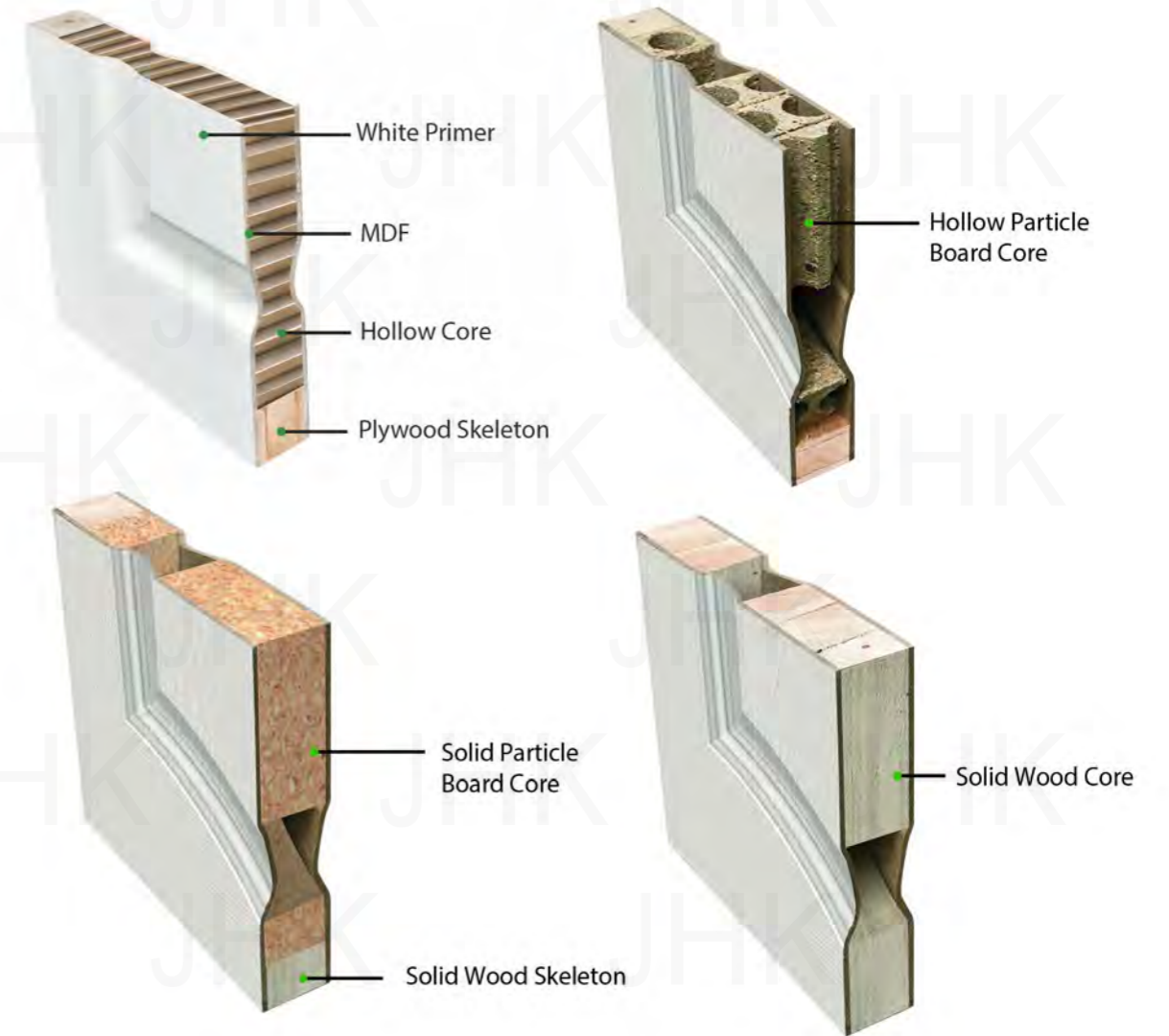

| White Primer Door | | | | | |
|--|-------------------|----------------------|----------------------------|-------------------------------|--|
| Size | Material | | Surface | Painting Option | |
| | Fill-in Core | Skeleton | | | |
| 1. Height: 1900-2100mm (74.80-82.68in) | 1. Hollow Core | 1. Finger Joint Wood | 1. Smooth White Primer | 1. White Primer | |
| 2. Width: 610-1000mm (24-39.37in) | 2. Particle Board | 2. Plywood | 2. Wood Grain White Primer | 2. PU Painting UV Painting | |
| 3. Thickness: 35-45mm (1.375-1.75in) | 3. Solid Core | | | 3. Water Borne Painting | |



| Size | Filler | Surface | Packing | Depth | Jamb Thickness |
|---------------------------------------|-----------------------|--------------|---------|--------|----------------|
| 24"x80"x1-3/8" (610mmX2032mmX35mm) | Honeycomb | Wood Texture | Bulk | 8mm | 18mm |
| | Hollow Particle Board | | Pallet | 12mm | |
| | Solid Particle Board | Smooth | Prehung | 16.8mm | 24mm |
| | Solid Wood | | | | |



JHK-002 Wood Grain



JHK-003 Wood Grain



JHK-004 Wood Grain



JHK-007 Wood Grain



JHK-017 Wood Grain



JHK-F02 Straight Grain



JHK-F03 Wood Grain



JHK-F04
Vertical and Straight Grain



JHK-017 (Smooth)



JHK-M01 (Smooth)



JHK-M02 (Smooth)



JHK-M03 (Smooth)



JHK-M04 (Smooth)



JHK-M10 (Smooth)



JHK-M11 (Smooth)



JHK-S01 (Smooth)



JHK-S09 (Smooth)



JHK-S02 (Smooth)

JHK-S03 (Smooth)

JHK-S04 (Smooth)

JHK-S05 (Smooth)



JHK-001 (Smooth)

JHK-004P (Smooth)

JHK-006 (Smooth)



JHK-011 (Smooth)



JHK-015 (Smooth)



JHK-017 (Smooth)

